

Brio®

Brio® where ideas unfold

## Brio® 612 Retractable Pleated Insect Screen

For openings up to 3.2 metres high by 9 metres wide

## **Brio® where ideas unfold**

Watch your adventurous architectural ideas unfold into exciting reality with the Brio range of sliding and folding door hardware.

Brio is passionate about shaping the spaces in which people live, work and play. With subsidiaries in the UK and USA – Brio is recognised by architects worldwide as a leading design and manufacturing company.

Brio's R&D department brings a strong design element to the business, developing and testing ground breaking concepts that continue to be at the forefront of the industry.

So it's no surprise our name Brio translates to Energy, Spirit and Vitality – the core values that drive us to always discover new solutions for our customers.

We are committed to the continuous improvement of quality. That is why Brio, located in Sydney, is certified to Quality Management System AS/NZS ISO 9001:2015.

Brio, part of the Allegion family of brands





## Brio 612 Retractable Pleated Insect Screen

The Brio 612 Retractable Pleated Insect Screen offers a screening solution to any window or door application due to its innovative design. Developed for flexibility and tested for durability, the Brio 612 Screen is a popular product worldwide.

With the capability to span 4.5m, the Brio 612 Screen is one of the largest single action screen products of its type in the world. Meeting screens can cover an expansive opening of 9m wide and 3.2m high.

## Dimensions

Single Screen	Height	Width
Minimum	600mm	900mm
Maximum	3200mm	4500mm
Double Screen	Height	Width
Minimum	600mm	1800mm
Maximum	3200mm	9000mm

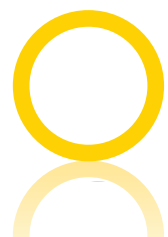



## Colours

Brio understands the importance of continuity for aesthetical purposes and so offers the Brio 612 Screen in Black, Silver and White with custom colours available.

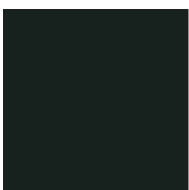

Black

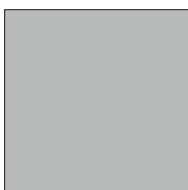

Silver



White

## Quality

The Brio 612 Screen is assembled in Australia with the finest quality materials to ensure excellence is maintained. Our purpose built robotic equipment provides accuracy and efficiency allowing the Brio team to act responsively for delivery of your screens.

The patented Brio 612 Screen has undergone rigorous testing and exceeded 150,000 cycles. The Brio 612 Screen warranty does not extend to damage caused to the mesh by pets, children or the occasional adult.

# Performance

High strength, braided tensioning cords run horizontally to stabilise the screen and control vertical orientation of the handle bar. These tensioning cords run over multiple precision bearings to ensure the high quality, European polyester mesh slides smoothly with a low operating force. The use of precision bearings significantly increase the screen's life.

The tensioning cords also prevent the mesh from blowing out in windy conditions. The mesh has been designed to leave the channel in windy conditions as a safety feature which helps prevent tearing. If the screen does leave the channel it can be easily placed back inside.

# Applications

The Brio 612 Screen is independent of any particular window or door system but can be easily installed on the inside frame of folding, sliding and french doors as well as many window types. This freedom allows the screen to be used in a multitude of applications. The intelligent design means the Brio 612 Screen can be fully integrated into windows and doors discreetly while in operation or retracted.

This is achieved with low profile aluminium sections and the pleated, UV stable mesh. Many systems offer a flat mesh which is prone to sagging and requires an unsightly canister to house the screen mesh. The Brio 612 Screen is tailor made to integrate seamlessly with Brio's Weatherfold exterior systems 4s (top hung), 5c (bottom folding) and Brio's Window or Servedy. It can also be used with our straight sliding systems Single Run and Timberoll.

# Retrofit Screening

New for the Brio 612 Screen is the ability to be added to pre-existing window and door systems which have suitable outer frames. The standard screen kit has been adapted to allow for face fix application which can be easily dressed by timber architraves.

A simple but effective solution to situations where a door system is already in place but without suitable insect screening. The versatile Brio 612 Screen can now rescue these systems and turn them into a full exterior door way system. The retrofit screen kit is also available in the 3 standard colours as well as custom colours making it truly integrated with existing fixtures.



# Postless Corner

An advantage of the Brio 612 Screen is the ability to screen corner openings without the need for a corner post, providing stunning uninterrupted views.

Corner applications are possible with all of Brio's Weatherfold exterior, folding systems and our hybrid sills which utilise timber and aluminium for self draining and easy installation.



# 612 Retractable Pleated Insect Screen with Folding Panels

Plan View - Brio Weatherfold 4s exterior folding door hardware, non mortice hinges

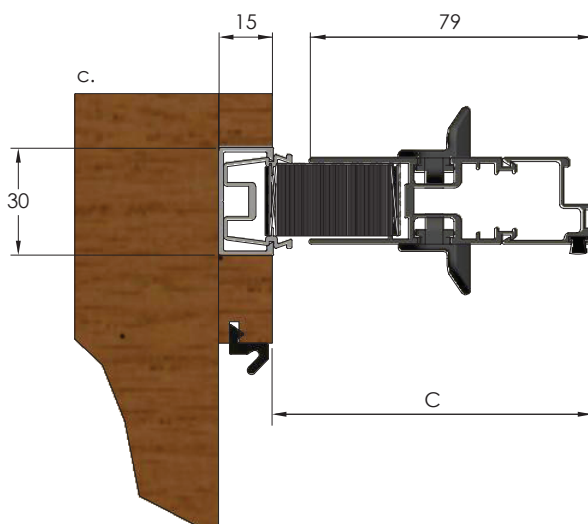
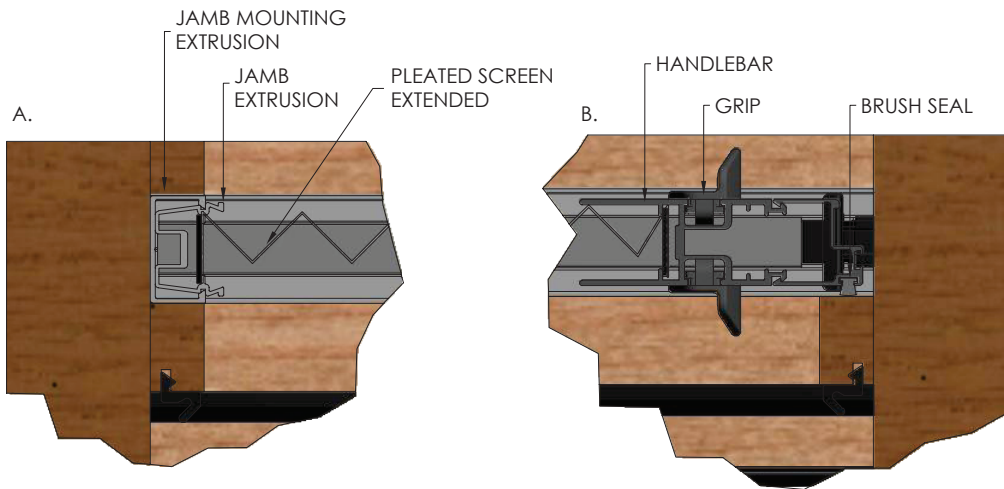

SCREEN WIDTH (MM)	DIMENSION C (OVERALL)
1100	85
1500	95
2000	110
2700	130
3600	155
4500	180

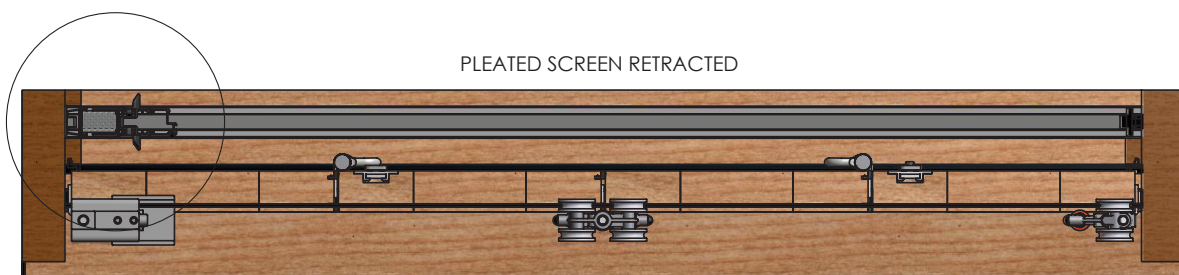



# 612 Retractable Pleated Insect Screen with Folding Panels

End View - Brio Weatherfold 4s exterior folding door hardware, non mortice hinges

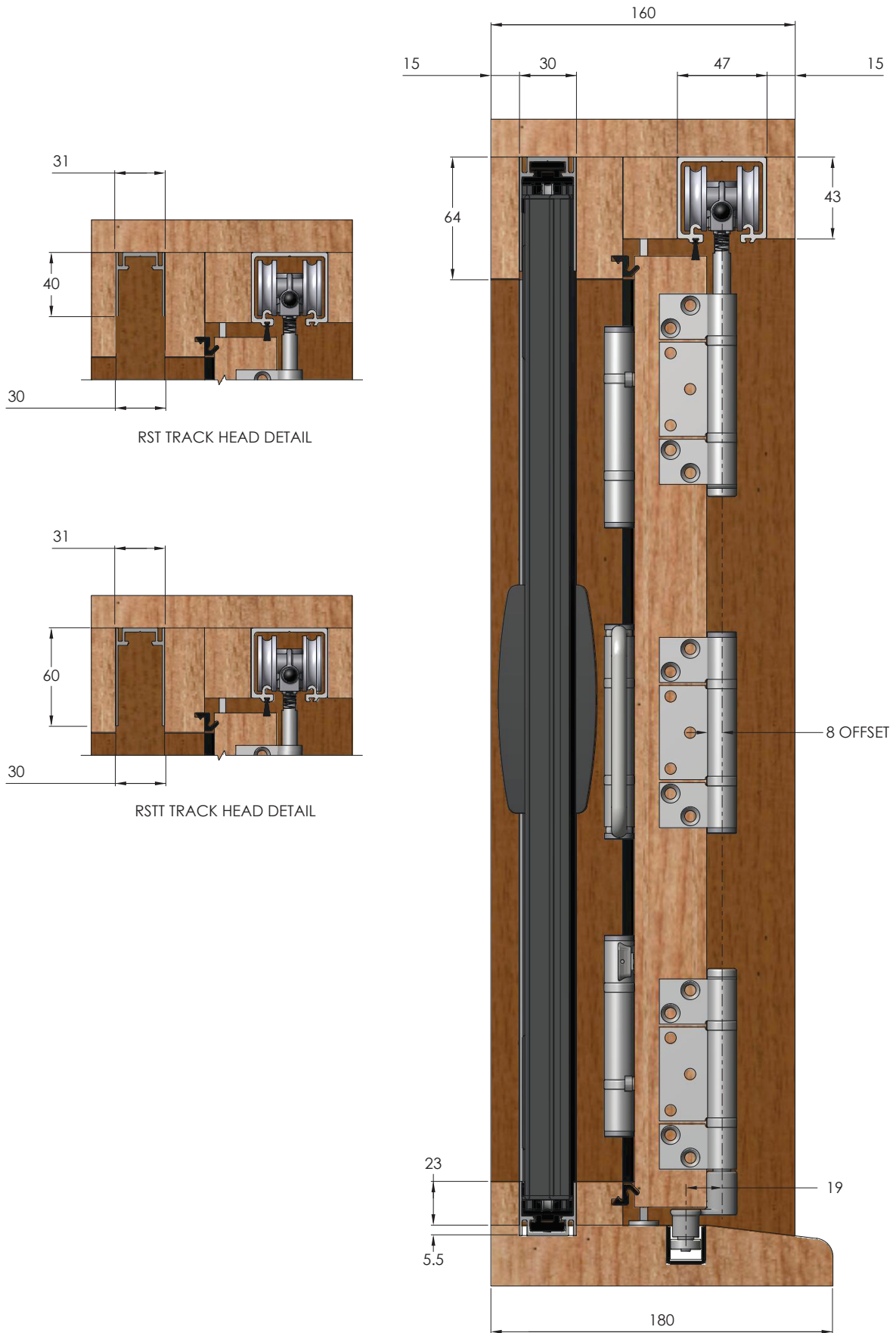

# 612 Retractable Pleated Insect Screen Retrofit

Plan View – Brio Weatherfold 4s exterior folding door hardware, non mortice hinges

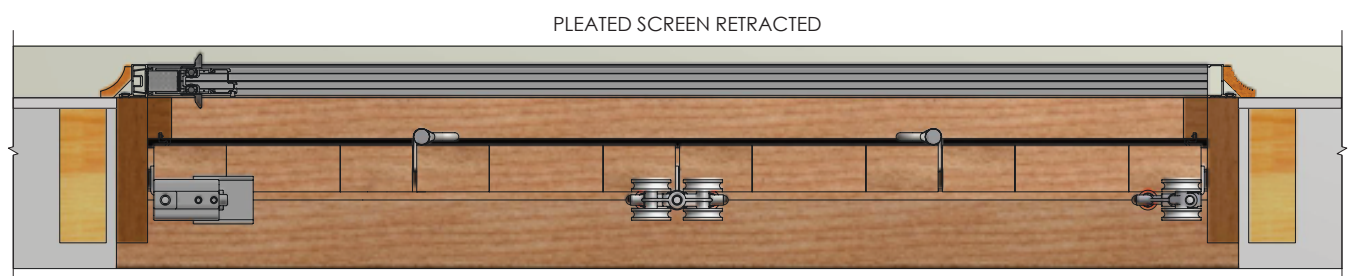
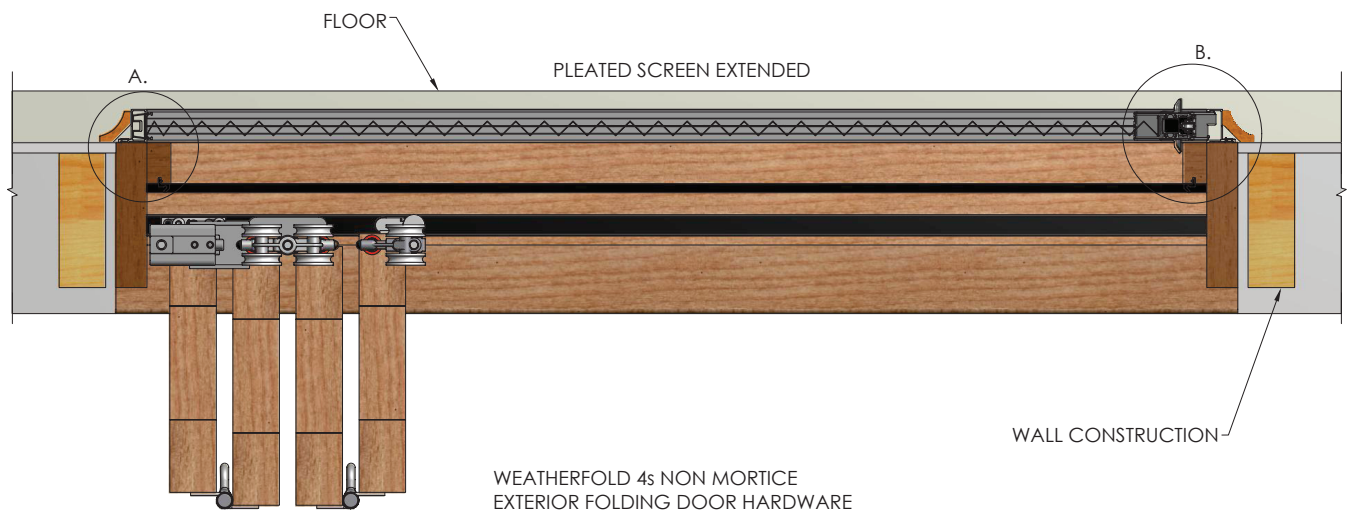
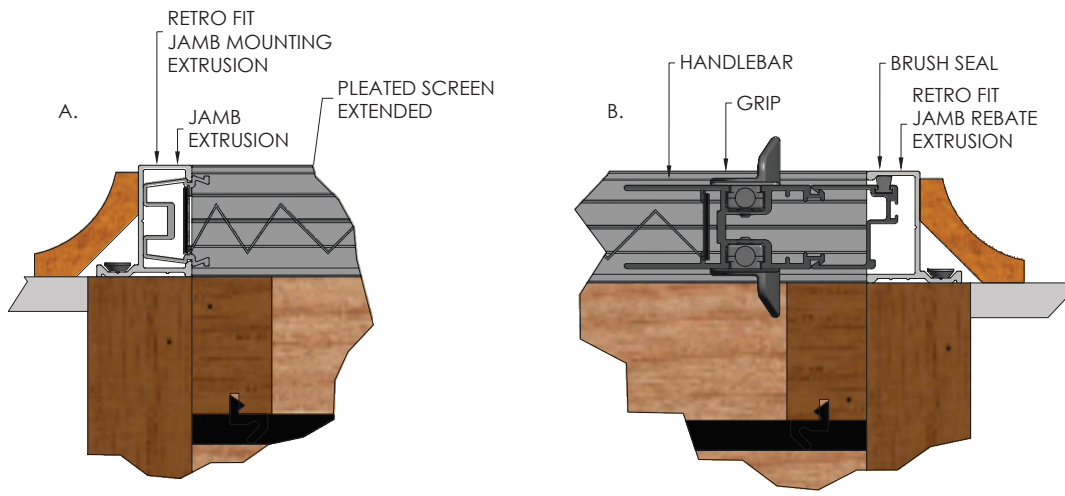

# 612 Retractable Pleated Insect Screen Retrofit

End View – Brio Weatherfold 4s exterior folding door hardware, non mortise hinges

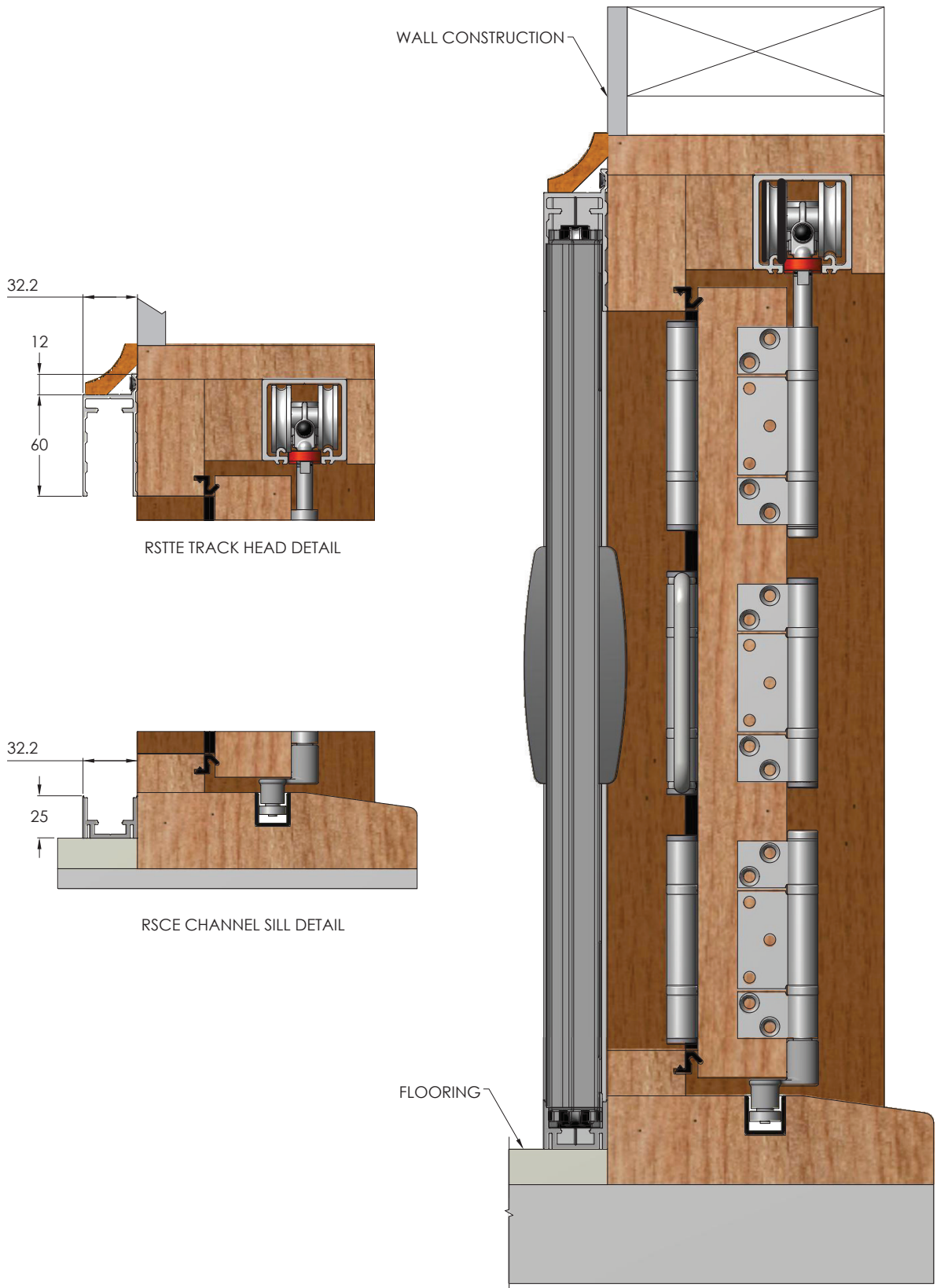

# 612 Retractable Pleated Insect Screen with Sliding Panels

Plan View – Brio Timberoll 200 exterior bottom roller sliding door hardware

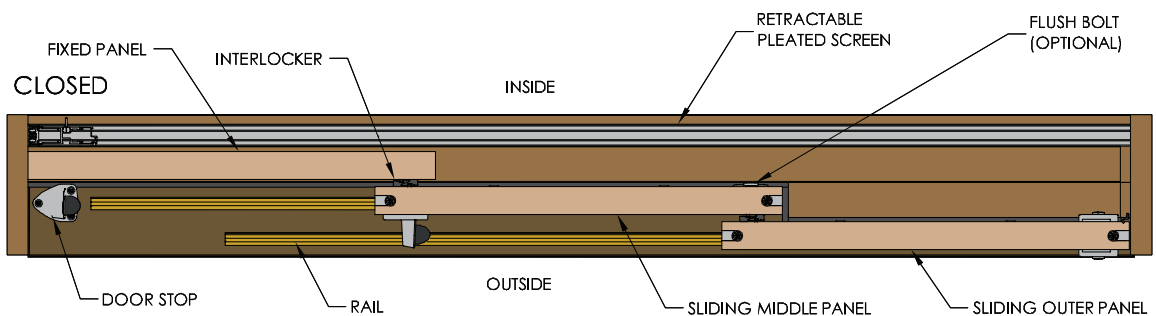
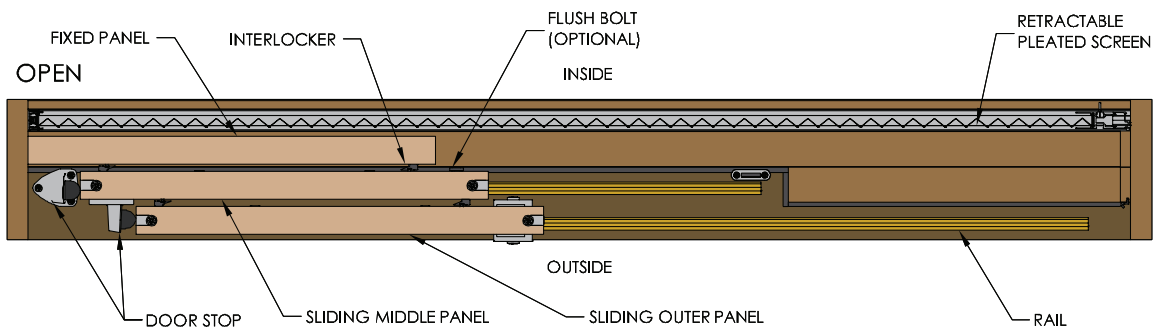
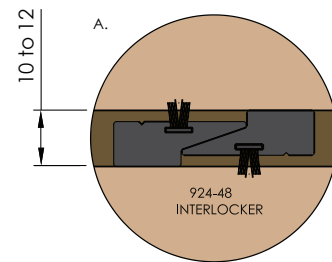
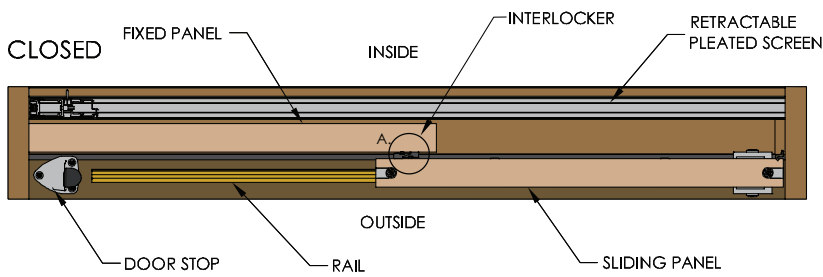
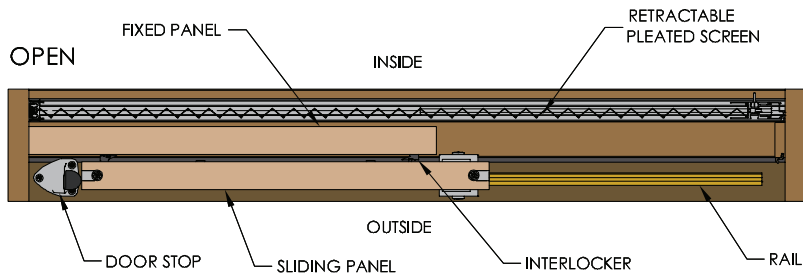

# 612 Retractable Pleated Insect Screen with Sliding Panels

End View – Brio Timberoll 200 exterior bottom roller sliding door hardware

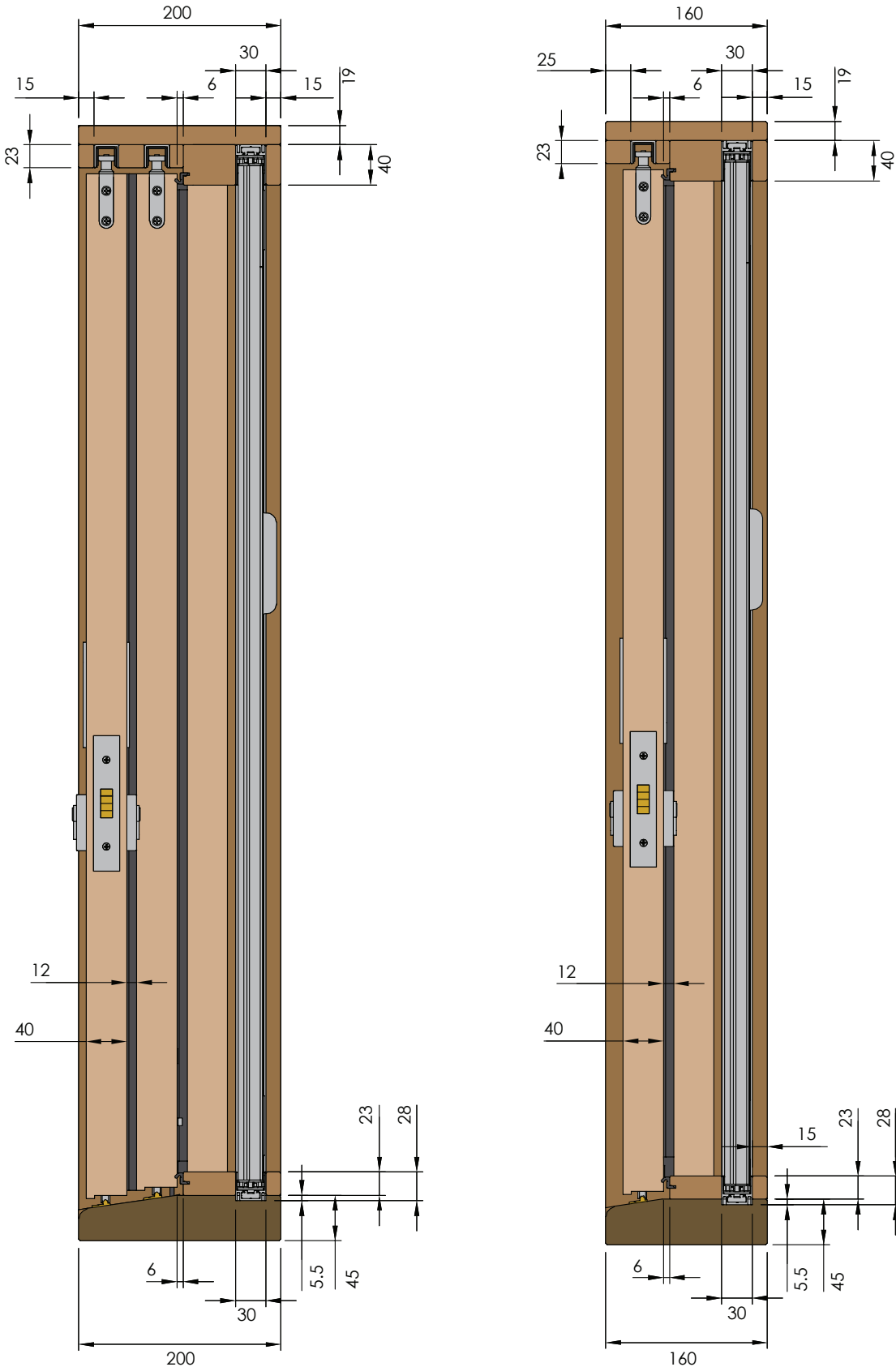

# 612 Retractable Pleated Insect Screen with Window

Plan View – Brio Weatherfold 4s Window exterior folding window hardware

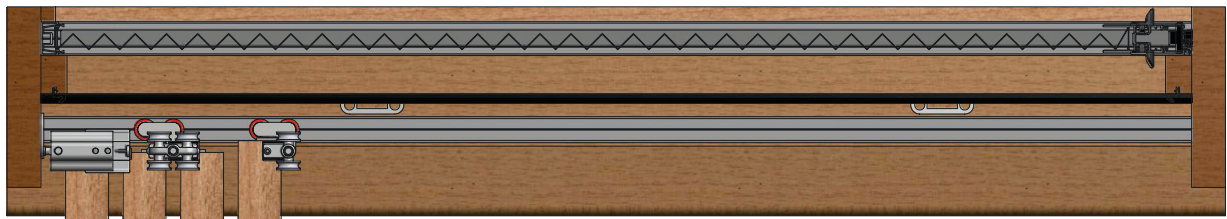

PLEATED SCREEN EXTENDED

WEATHERFOLD 4s NON MORTICE  
EXTERIOR FOLDING WINDOW 25 HARDWARE

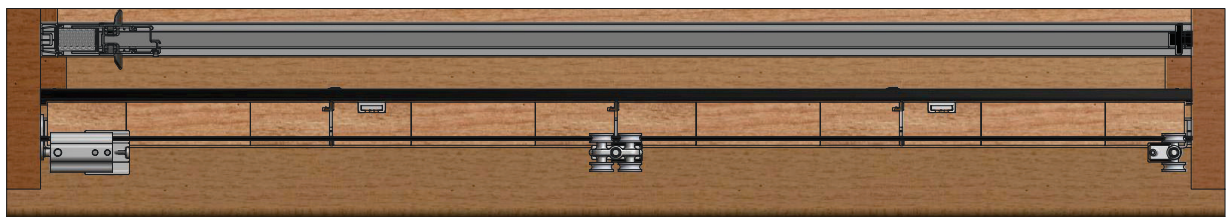

PLEATED SCREEN RETRACTED



# 612 Retractable Pleated Insect Screen with Window

End View – Brio Weatherfold 4s Window exterior folding window hardware

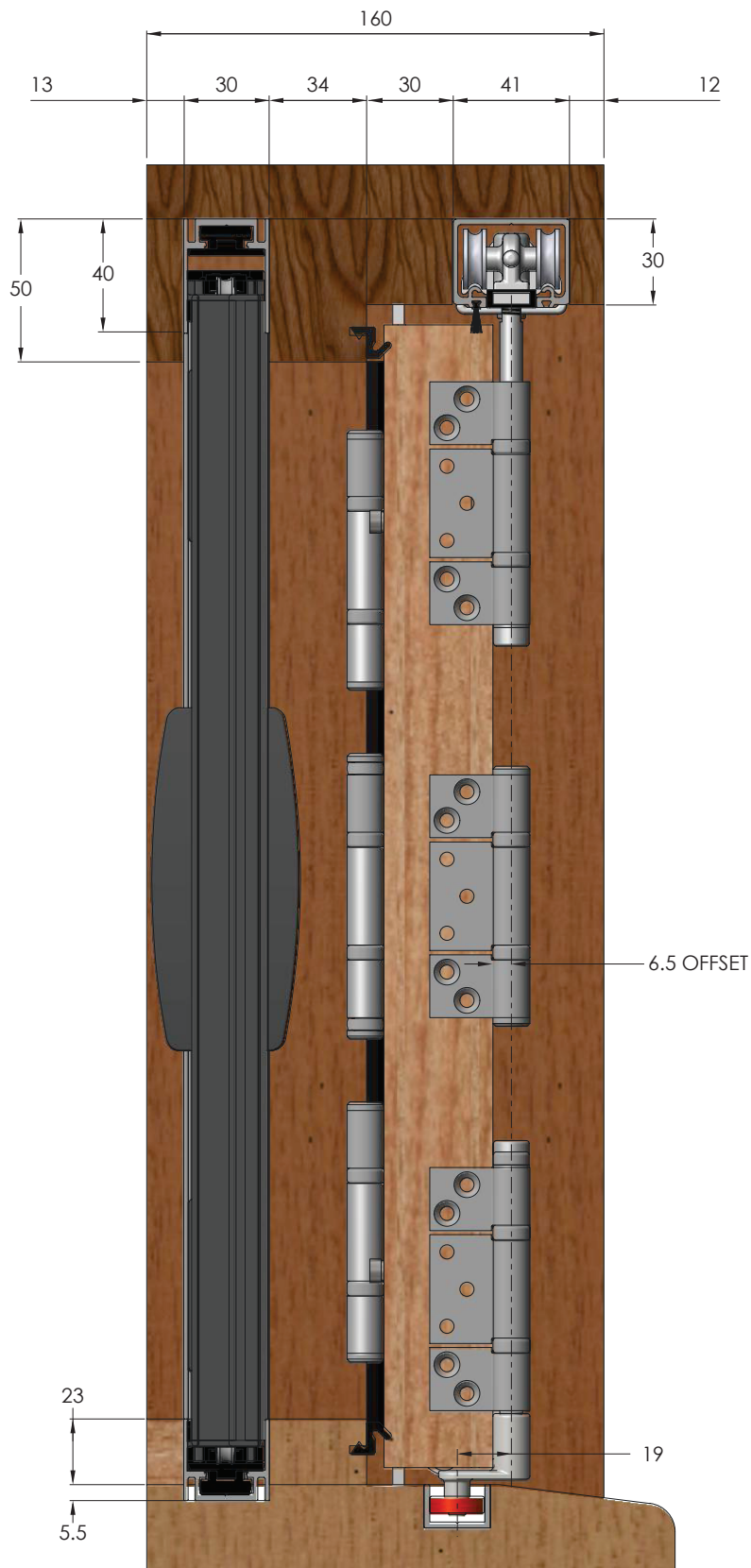

# 612 Retractable Pleated Insect Screen with Pocket

Plan and end view of pocket application

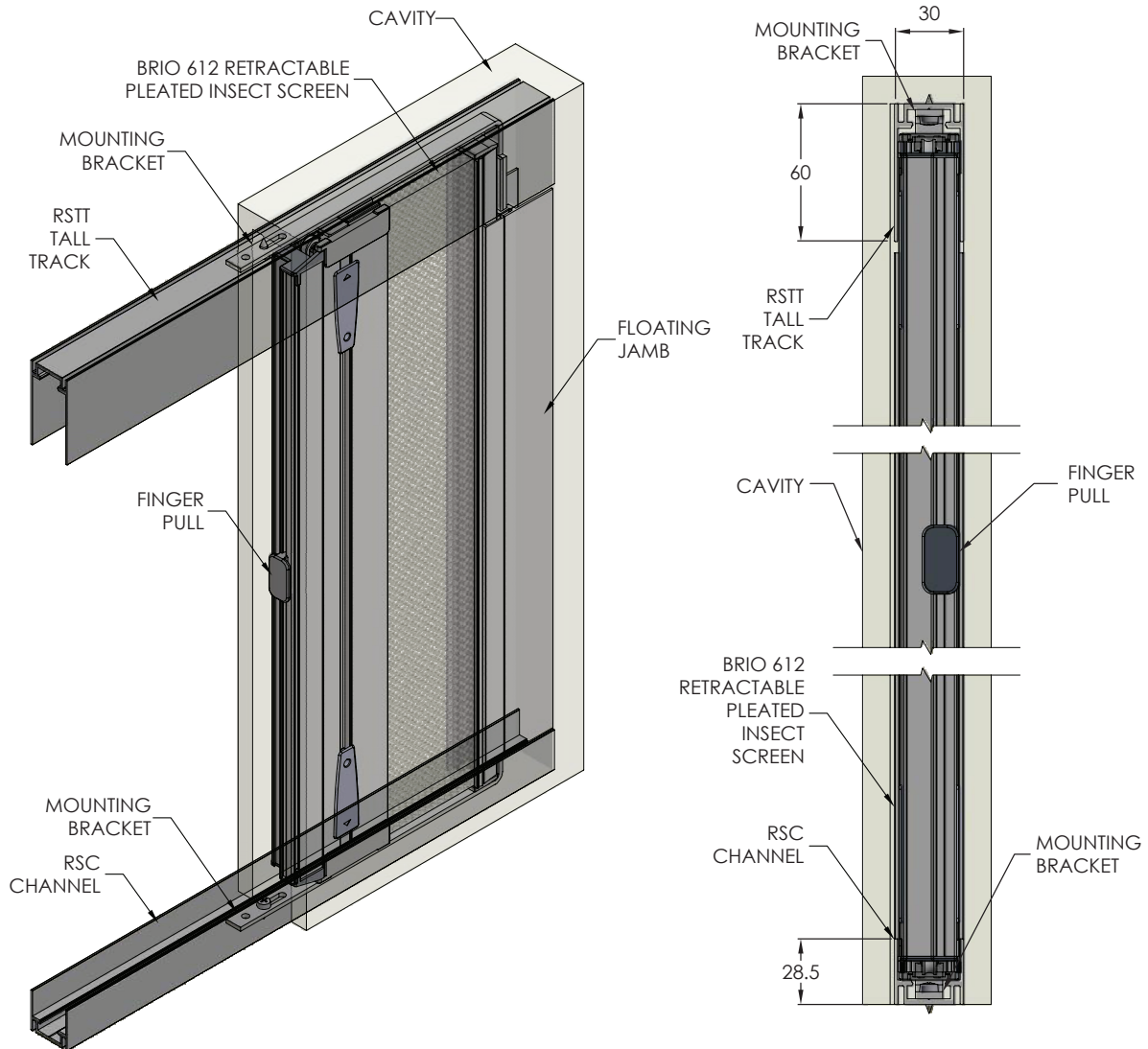

PLEATED SCREEN RETRACTED

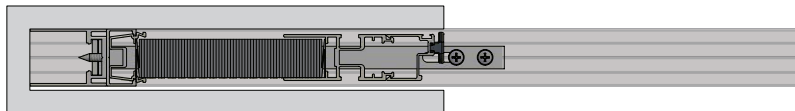

PLEATED SCREEN EXTENDED

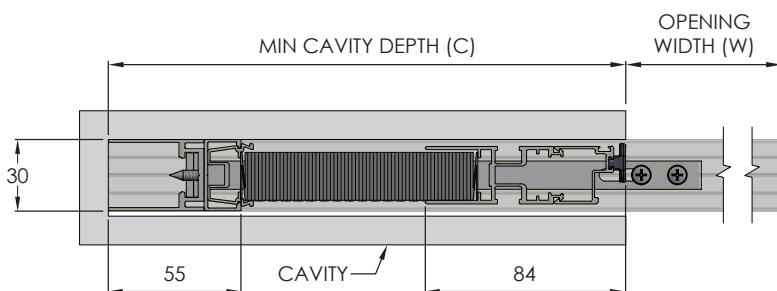
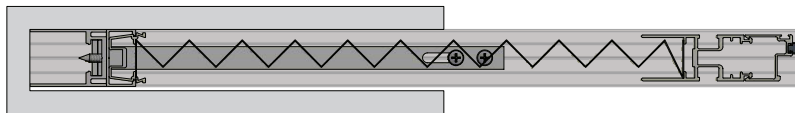

OPENING WIDTH (W)	SCREEN WIDTH	MIN CAVITY DEPTH (C)
955	1100	145
1345	1500	155
1832	2000	168
2515	2700	185
3382	3600	218
4255	4500	245



# Standard Sizes

Screen width reduces in size to the next smallest screen, eg. a 3600mm wide screen can be installed in an opening that is between 2700mm-3600mm wide. Screen height can be cut down by up to 200mm. Aluminium sections available in powder coat Black, Silver and White.

## Single Screen

		Width Range mm					
		900 - 1100	1100 - 1500	1500 - 2000	2000 - 2700	2700 - 3600	3600 - 4500
Height Range mm	3000 - 3200	KIT-9	KIT-9	KIT-10	KIT-11	KIT-12	KIT-12
	2800 - 3000	KIT-9	KIT-9	KIT-10	KIT-11	KIT-12	KIT-12
	2600 - 2800	KIT-9	KIT-9	KIT-10	KIT-11	KIT-12	KIT-12
	2400 - 2600	KIT-9	KIT-9	KIT-10	KIT-11	KIT-12	KIT-12
	2200 - 2400	KIT-5	KIT-5	KIT-6	KIT-7	KIT-8	KIT-8
	2000 - 2200	KIT-5	KIT-5	KIT-6	KIT-7	KIT-8	KIT-8
	1800 - 2000	KIT-5	KIT-5	KIT-6	KIT-7	KIT-8	KIT-8
	1600 - 1800	KIT-5	KIT-5	KIT-6	KIT-7	KIT-8	
	1400 - 1600	KIT-5	KIT-1	KIT-2	KIT-3	KIT-4	
	1200 - 1400	KIT-5	KIT-1	KIT-2	KIT-3		
	1000 - 1200	KIT-1	KIT-1	KIT-2	KIT-3		
	800 - 1000	KIT-1	KIT-1	KIT-2			
600 - 800	KIT-1	KIT-1	KIT-2				

Corresponding kit number shown in table

Example Screen Code **RSDL3200-1100PBK**

-3200 High  
-1100 Wide  
-Powder Coat Black

### Single Screen

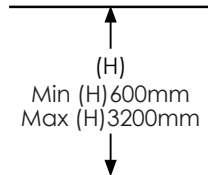
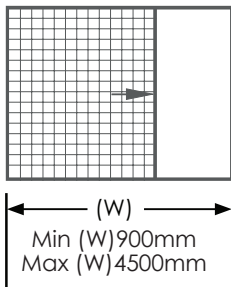

### Double Screen

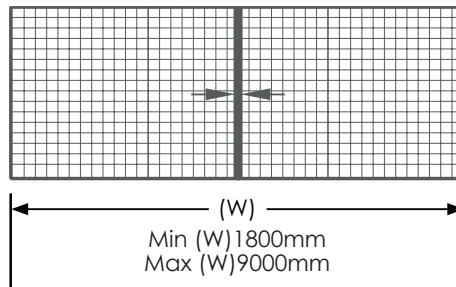

## Double Screen

		Width Range mm					
		1800 - 2200	2200 - 3000	3000 - 4000	4000 - 5400	5400 - 7200	7200 - 9000
Height Range mm	3000 - 3200	•	•	•	•	•	•
	2800 - 3000	•	•	•	•	•	•
	2600 - 2800	•	•	•	•	•	•
	2400 - 2600	•	•	•	•	•	•
	2200 - 2400	•	•	•	•	•	•
	2000 - 2200	•	•	•	•	•	•
	1800 - 2000	•	•	•	•	•	•
	1600 - 1800	•	•	•	•	•	
	1400 - 1600	•	•	•	•	•	
	1200 - 1400	•	•	•	•		
	1000 - 1200	•	•	•	•		
	800 - 1000	•	•	•			
600 - 800	•	•	•				

Combination of kits required





## About Allegion

Allegion (NYSE: ALLE) is a global pioneer in safety and security, with leading brands like Brio®, FSH®, LCN®, Legge®, Schlage® and Von Duprin®. Focusing on security around the door and adjacent areas, Allegion produces a range of solutions for homes, businesses, schools and other institutions. Allegion is a \$2.4 billion company, with products sold in almost 130 countries. For more, visit [www.allegion.co.nz](http://www.allegion.co.nz)

# A passion for excellence

Brio ■ Briton ■ <FSH> ■ LCN ■ LEGGE ■ SCHLAGE ■ VON DUPRIN ■ ZERO INTERNATIONAL

### Allegion New Zealand

Freephone 0800 477 869

Freefax 0800 477 868

Email [nzinfo@allegion.com](mailto:nzinfo@allegion.com)

[www.allegion.co.nz](http://www.allegion.co.nz)

© 2018 Allegion

